

Combining elegance and functionality

Geberit Monolith WC Module



Know-how
from
Switzerland

A design solution that adapts easily to existing drains.

Geberit Monolith WC Module is an elegant sanitary module for WCs with an integrated cistern that can be quickly installed using existing connections and drains. Combining simple, sophisticated design with high quality materials, Geberit Monolith WC Module creates a harmonious interaction between bathroom and ceramic pan. Easily installed and maintained without the need for structural alterations, Geberit Monolith WC Module provides a stylish addition to your bathroom sanctuary.

Scope of supply

Frame, Cistern tank, mounting hardware, Front/Side cladding (Glass & Aluminum or Plastic), Complete water connection set 1/2" & 3/8", Complete waste water connection set, 2 kee seals and mounting instructions.



iF Product Design Award

The iF product design award has been a seal of quality for outstanding industrial design since 1953. Awarded by international experts the iF logo stands for outstanding, tried-and-tested design quality.

Advantages at a glance



Plug & Play

Geberit Monolith WC Module can be connected to existing drains and water supply connections without the need for structural modifications in most bathrooms. No chiselling, no tiling, no rubble. Installation of the entire system is completed in a single operation and requires no assistance from other tradesmen. This means the toilet is ready for use again after a matter of hours.

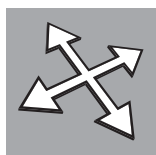

Flexibility

Geberit Monolith WC Module fits into any construction situation. It is modular in design and easily compensates for building tolerances. The same flexibility applies to the drain: Geberit Monolith WC Module is quickly and easily connected to the floor waste inlet.



Top quality

The sanitary module is made of premium material including safety glass and aluminium. The technical components are finished to the superior standards you expect of Geberit.



Low maintenance

Valves are directly accessible for easy maintenance. All components match Geberit's own high quality standards and availability of spare parts is guaranteed for years to come.



Versatility

Geberit Monolith WC Module can be combined with many types of ceramic pans for floor-standing toilets.



Models and features



Glass, mint green (SK) coated



Glass, black (SJ) coated



Glass, white (SI) coated

Glass edges	ground	polished	polished
Side	White	Brushed aluminium	Brushed aluminium
Applications	– Floor-standing WC for installation flush with wall	– Floor-standing WC for installation flush with wall	– Floor-standing WC for installation flush with wall



Watermark approval - C of C 4000 – WELS approval and rating of 3Star

131.005.SI.1	Monolith BTW WC, white/aluminium, 6/3L AU
131.005.SJ.1	Monolith BTW WC, black/aluminium, 6/3L AU
131.005.SK.1	Monolith BTW WC, green/white, 6/3L AU



Watermark approval - C of C 4000 – WELS approval and rating of 4Star

131.006.SI.1	Monolith BTW WC, white/aluminium, 4.5/3L AU
131.006.SJ.1	Monolith BTW WC, black/aluminium, 4.5/3L AU
131.006.SK.1	Monolith BTW WC, green/white, 4.5/3L AU



Main applications

For floor-standing, back to wall WC pans
 Online catalogue from Geberit www.geberit.com.au



Accessories



131.082.16.1 S Bend connection set 90 mm complete



131.083.16.1 P trap connector with collar 90 mm



131.073.00.1 Bottom water connection set complete



131.081.11.1 Waste connection set complete

Installation

Geberit Monolith sanitary WC module is an innovative product which offers fast and near dirt free renovation with back to wall pan. The cistern can be installed without impacting walls or structural elements of a bathroom as existing water and waste connection points can be utilised.

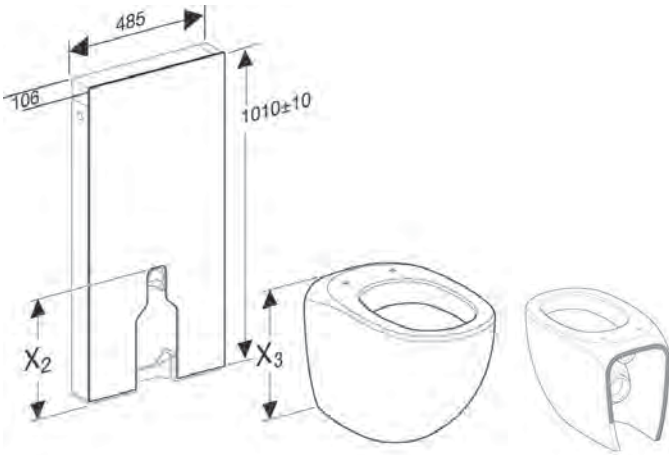

Geberit Monolith WC Module can be paired with most back to wall pans.

Important:

- > Check supplier's specification.
- > Pan needs to be open and unrestricted at the rear.

X ₁	D	X ₂
320-335	910	375
340	910	380
345	910	385
350	910	390

Finished Floor Level to the centre of the flush pipe must be between 320-350 mm range.

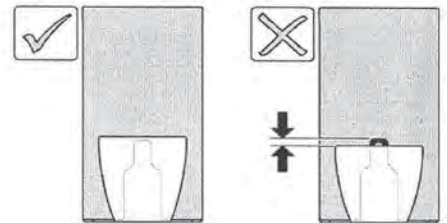
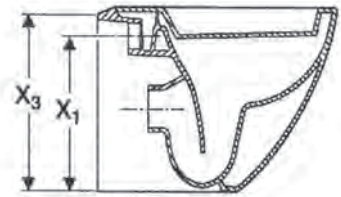
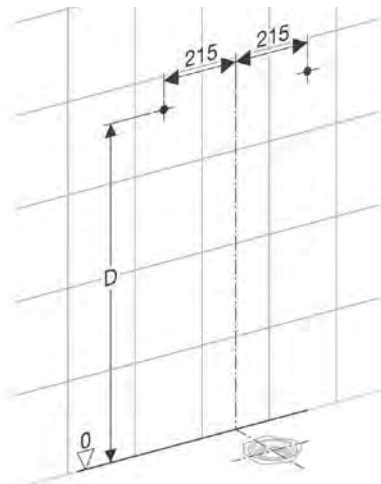

Ensure that pan height is greater than glass cut out by at least 5 mm

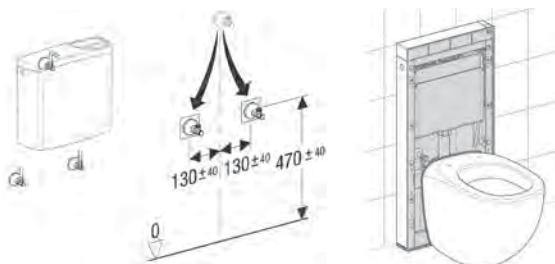

Water connection point may have to be altered to fit inside the frame perimeter

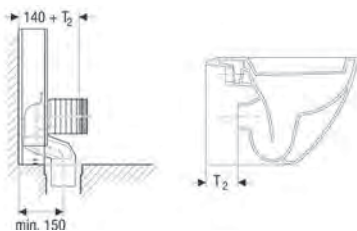

Waste connection measurements in conjunction with P-bend

For waste connections < 150mm use Art. No. 131.082.16.1 WC S-bend Connector Set

Geberit Pacific Head Office
Unit 8a
6-8 Byfield Street
Macquarie Park NSW 2113
Australia

T: +61 2 9889 7866

F: +61 2 9889 7855

E: sales.au@geberit.com

→ www.geberit.com.au