

RONDO ALUMINIUM COMPONENTS

The Rondo Aluminium Ceiling System is an alternative to the Rondo DUO Exposed Grid Ceiling System. Unlike the DUO system, the Aluminium Main Tee to Cross Tee intersection is a butt joint which provides a flat, ghost free surface into which the ceiling panel fits.

The Cross tees have integrated locking tags enabling them to snap together positively at intersections whilst the Main Tee has a separate splicing plate to join lengths of the Main Tee together.

PRIMARY SECTIONS

357	24mm Face x 38mm Aluminium Cross Tee
359	24mm Face x 38mm Aluminium Lightweight Main Tee

PRIMARY SECTIONS



PRIMARY SECTION JOINER



PRIMARY SECTION JOINER

358	359 Main Tee Joiner
-----	---------------------

WALL ANGLES

DUO 7	Shadowline Wall Angle: Aluminium 19 x 9 x 9 x 15mm
DUO 8	Aluminium Wall Angle: 32 x 19mm

WALL ANGLES

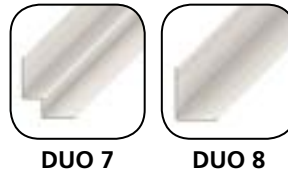

BULKHEAD TRIM

321	Aluminium Direct Fix – 13mm PB
-----	--------------------------------

BULKHEAD TRIM



PRIMARY SUSPENSION CLIP



PRIMARY SUSPENSION CLIP

356	Spring Adjusted to suit 359
-----	-----------------------------

SUSPENSION ROD BRACKETS

247	Suspension rod Angle Bracket
274	Suspension rod bracket
534	Suspension rod bracket: Timber – Steel
547	Suspension rod bracket: Concrete

SUSPENSION ROD BRACKETS



SUSPENSION ROD

121	5mm Soft Gal. Susp. Rod
-----	-------------------------

SUSPENSION ROD



ANGLE BRACKET



ANGLE BRACKET

188	Angle Bracket
-----	---------------

TOUCH-UP PAINT

772	For steel and aluminium grid (150g can)
-----	---

TOUCH-UP PAINT



ACCESSORIES

ACCESSORIES

705	Stabiliser Clip DUO5/DUO8 – Main Tee/Cross Tee
706	Stabiliser Clip DUO6 /DUO7– Main Tee/Cross Tee



TYPICAL APPLICATION & INSTALLATION DETAILS

The typical application and installation details for Rondo's Aluminium Ceiling System are the same as for Rondo's DUO Exposed Grid Ceiling System, **except for the following differences:**

356 SUSPENSION CLIP

The 356 Suspension Clip slips over the upstand of the 359 Main Tee so that its locating lug 'clicks' into the pre-drilled hole in the tee section. The ceiling is leveled by squeezing the prongs of the clip together and sliding the assembly up or down the suspension rod until the required level is achieved then releasing the clip (see Figure 1).



■ 356 CLIP AND 359 MAIN TEE

JOINING 357 AND 359 TEES

When the Main 359 and Cross 357 Tees are joined, the sections 'butt' together forming a smooth 'ghost' free intersection (see Figure 2).

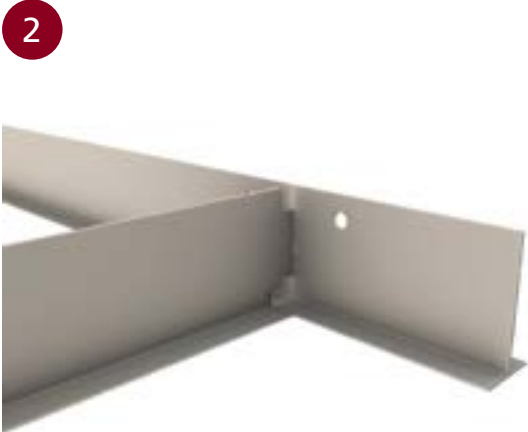

■ 357 & 359 TEES JOINED

TYPICAL APPLICATION & INSTALLATION DETAILS (continued)

358 JOINER PLATE

The 359 Main Tees are joined by the 358 Joiner Plate and secured to form a tight junction by bending the tabs closed once positioned through the pre-formed slots in the Main Tee (see Figures 3 & 4).

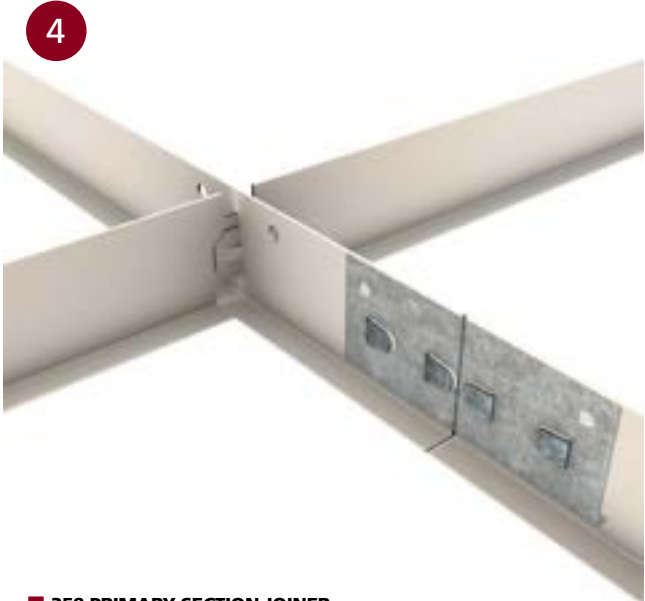

■ 358 PRIMARY SECTION JOINER

DUO7 & DUO 8

The same aluminium perimeter trims used with the DUO® system are colour matched to this aluminium system.

Both the DUO7 Shadowline and DUO8 Angle can be used with DUO Perimeter Trim Stabiliser Clips, Rondo 705 (for DUO8) and 706 (for DUO7) (see Figures 5 & 6)

The standard perimeter finish is to rest the abutting tee sections onto the perimeter trim. "Cutting" the tee sections into the perimeter trim is an impractical exercise as movement in the ceiling or the perimeter walls will result in unsightly gaps between grid and trim at perimeters.



188 ANGLE BRACKET

If for any reason, such as bulkhead trimming, it is necessary to join the grid and trim permanently the 188 Angle Bracket can be used with self tapping screws or pop rivets through its pre-drilled holes.



321 BULKHEAD TRIM

The 321 pre-finished aluminium bulkhead trim provides a matching element between plasterboard bulkheads and the aluminium grid ceiling.

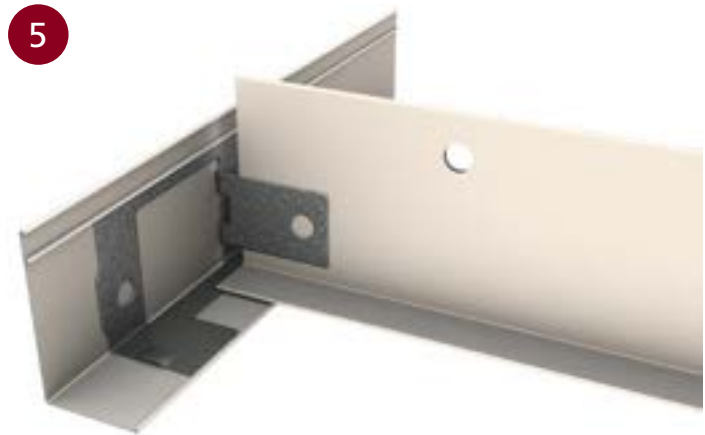

■ DUO8 WITH 705 CLIP

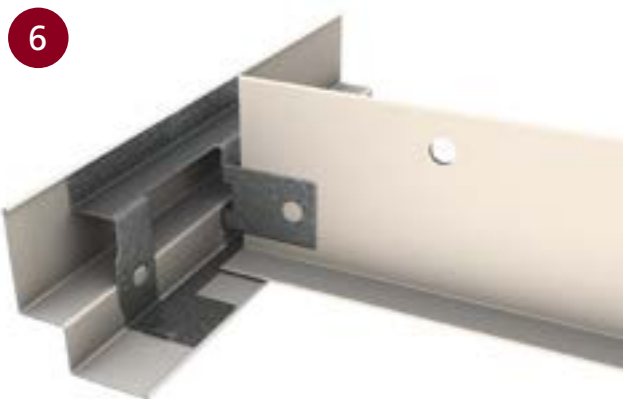

■ DUO7 WITH 706 CLIP

ALUMINIUM STANDARD GRIDS

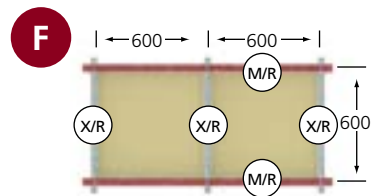
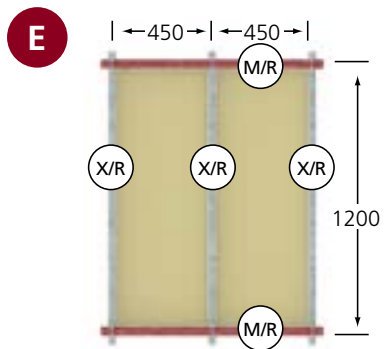
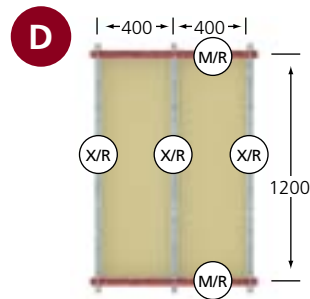
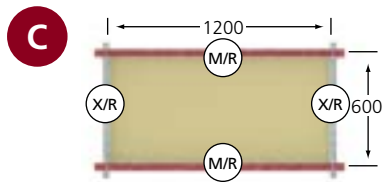
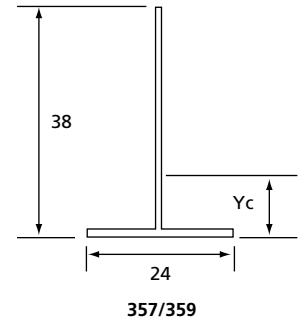
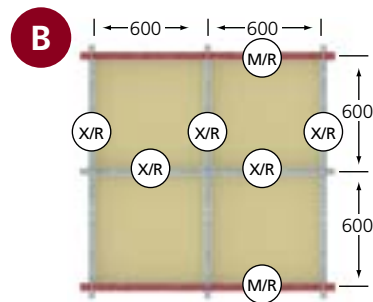
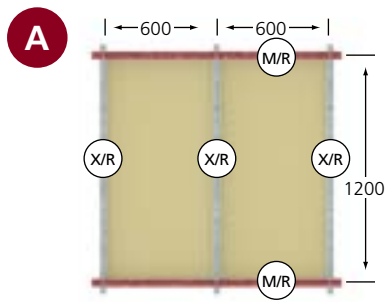

TABLE 4: SECTION DIMENSIONS

RONDO PART NO	D mm	AREA mm ²	Xc mm	Yc mm	WEIGHT kg/m
357/359	38.10	75.47	12.0	12.16	0.204

ALUMINIUM GRID SELECTION GUIDE

TABLE 5: TEE SPACING/MAX. ALLOWABLE LOADS

SYSTEM	M/R SPAN mm	M/R TYPE	X/R TYPE	ALLOWABLE LOAD kg/m ²
A	1200	359	357	7.0
B	1200	359	357	7.2
C	1200	359	357	10.4
D	1200	359	357	10.1
E	1200	359	357	9.5
F	1200	359	357	10.4

NOTE:

Allowable loads are based on suspension points at 1200mm centres along the Main Tee.

All light fittings are to be supported on Main Tees with additional hangers fitted, as required.

All maximum allowable load values stated assume the Main Tees are continuously spanned over three (3) or more suspension points.