

Architectural Grates + Drains

Designed and manufactured in Australia.





Slimline by Stormtech

The Slimline series is a patented, Australian designed and made lineal grated drain system that can be used anywhere a high performance, high quality, contemporary style drainage solution is needed.

Stormtech grates are made of stainless steel and are manufactured in Australia to ensure consistent high quality and timely supply.



Architectural + Residential

Balconies

Bathrooms

Courtyards

Doortracks

Driveways

Paved Areas

Patios

Pools

Suspended Slabs

Thresholds

Wet Areas

A narrow profile and high efficiency lineal drainage system that creates an aesthetically pleasing solution to the traditional grated drain.

The quality finish, blends well with designed contours and suits a variety of surfaces including pavers, tiles, concrete and vinyl.



Grate Design

Hospitality Industry



Bars and Restaurants

Kitchens

Bathrooms and Showers

Pools

Hotels and Resorts

Thresholds

Unique in their efficiency and versatility, Stormtech grates are ideal for new construction as well as retrofitting during renovation.

Providing a beautiful finish and ease of access for architectural requirements.

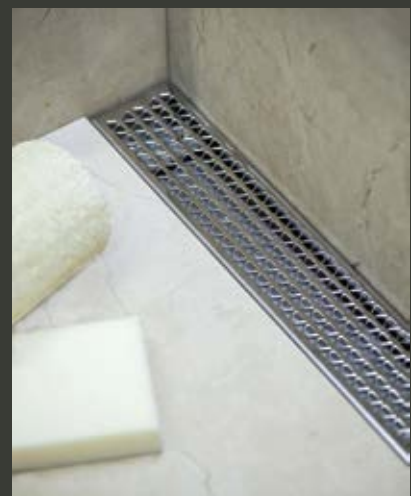

Marc Newson.

Hospitals + Aged Care

Bathrooms

Doortracks

Dining areas

Outdoor areas

Showers

Thresholds

Originally designed for those with special needs, Stormtech Slimline grates allow hobless entry to the shower and more room to manoeuvre in the bathroom. The shower floor falls in one direction, giving greater stability to a wheelchair or stool, and avoids rocking.

Stormtech Slimline grates allow disabled people a greater self-sufficiency in the bathroom.



Grate
versatility.

Commercial Projects

Airports

Carparks

Parks and Playgrounds

Public Areas

Sporting Grounds

Gymnasiums

Thresholds

The range of Stormtech Slimline products are suitable for many commercial purposes and large-scale outdoor applications.

Aesthetically pleasing, they provide extreme efficiency and ease of access in high traffic areas.



Custom Range + Service

Available
Grate Styles



AR



TR

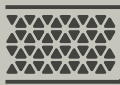

MND



Ti

**Custom
Made**

For site specific needs or unusual situations, choose from our Custom Fabrication range.

Stormtech can customise any drainage requirements to achieve maximum efficiency or match specific design requirements.

Drain designs can be manufactured to any particular size and Grate design can be personalised in a variety of colours or finishes.

316
GRADE

304
GRADE

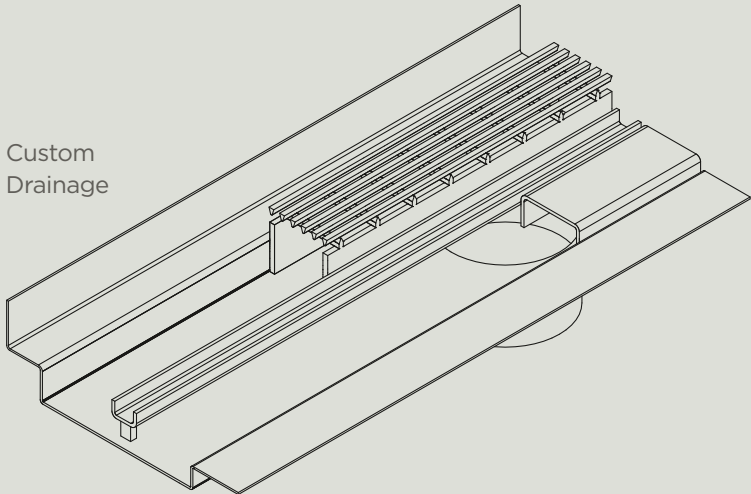

Custom
Drainage



Product Range

The Stormtech range is designed with flexibility in mind.

Simply decide your grate width and style, channel depth and length (fixed or modular).

Product Code Guide

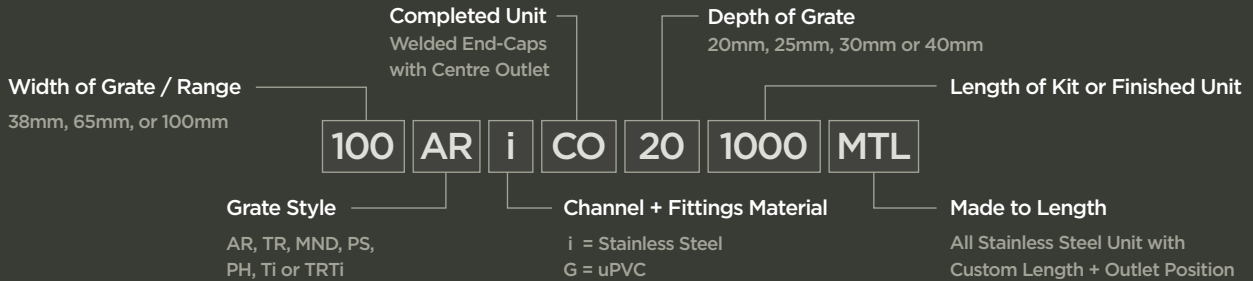

100 Range

Available Grate Styles



AR



TR

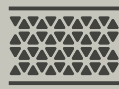

MND



PS



Ti



TRTi

100AR

The 100AR is the original premium architectural grate featuring a 2mm wire/2.5mm gap.

Manufactured from 316 marine grade stainless steel, the 100AR is 100mm wide and available in 20mm depth as Modular or Fixed-Length Units. Made-to-Length available in 20mm and 40mm depths.

316
GRADE

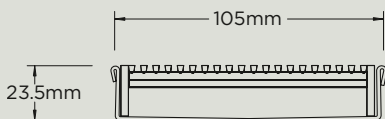

100ARi20

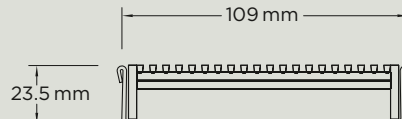

100ARiCO20

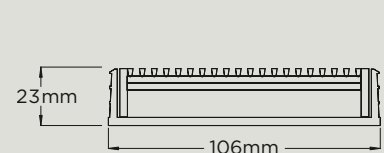

100ARG20

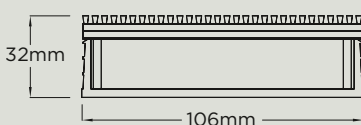

100ARG30

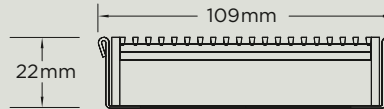

100ARi20MTL

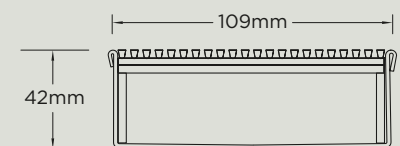

100ARi40MTL

100TR

The 100TR is a standard style grate featuring a 3mm wire/5mm gap.

Manufactured from 316 marine grade stainless steel, the 100TR is 100mm wide and available in 20mm depth as Modular or Fixed-Length Units, and 40mm or 20mm as Made-to-Length.

316
GRADE

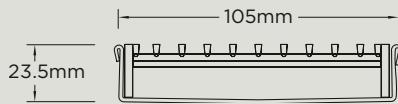

100TRi20
100TRiCO20

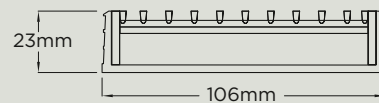

100TRG20

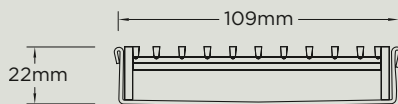

100TRi20MTL

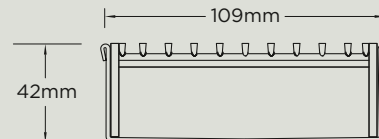

100TRi40MTL

100Ti

The 100Ti is a premium Tile Insert drain designed to blend seamlessly with tiled floors.

Our premium Tile Insert is manufactured from 3mm stainless steel.

The 100Tii30MTL and 100TiiCO30 are suitable for tiles up to 12mm deep. The 100Tii40MTL is suitable for tiles up to 16mm deep.

316
GRADE

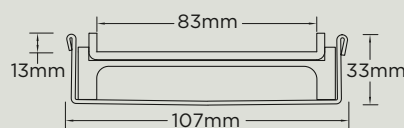

100Tii30MTL
100TiiCO30

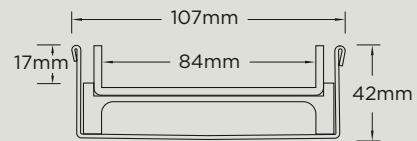

100Tii40MTL

100TRTi

The 100TRTi is a standard Tile Insert drain designed to blend seamlessly with tiled floors.

Our standard Tile Insert is made from 1.5mm stainless steel.

The TRTi is suitable for a tile up to 8mm deep.

316
GRADE

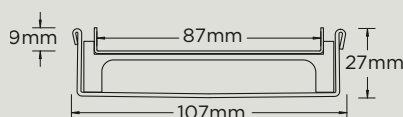
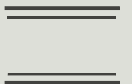

100TRTi25MTL
100TRTi25MTL

100 Range

100MND20

Our designer grate featuring a tessellated hexagonal design created in collaboration with Marc Newson.

Finishes: Stainless Steel, Black, White, Brass, Blue

5
FINISHES

316
GRADE

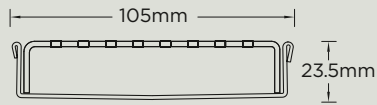
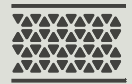

100MNDi20
100MNDiCO20

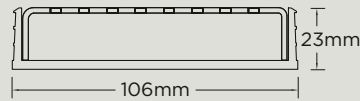

100MNDG20

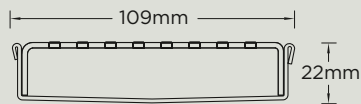

100MNDi20MTL

100PS

The 100PS is a Punched Slot grate design.

Manufactured from 316 marine grade stainless steel, the 100PS is 100mm wide and available in 20mm depth as Modular Kits or Fixed-Length Units, and 40mm and 20mm as Made-to-Length.

316
GRADE

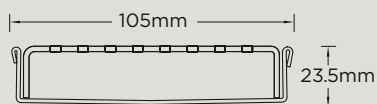

100PSi20
100PSiCO20

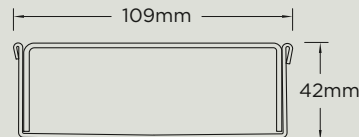

100PSi40MTL

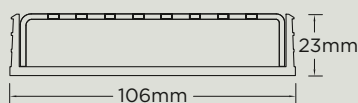

100PSG20

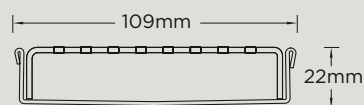

100PSi20MTL

65 Range

Available
Grate Styles

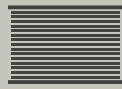

AR



TR

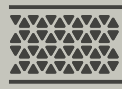

MND



PS

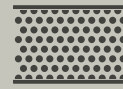

PH



Ti



TRTi

65AR

The 65AR is our original premium architectural grate and features a 2mm wire/2.5mm gap.

Manufactured from 316 marine grade the 65AR is 65mm wide and available in both 25mm and 40mm depths.

316
GRADE

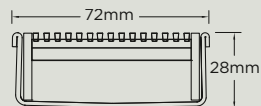

65ARi25
65ARiCO25

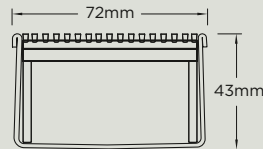

65ARi40

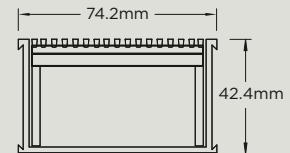

65ARG40

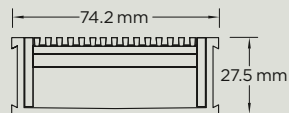

65ARG25

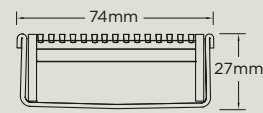

65ARi25MTL

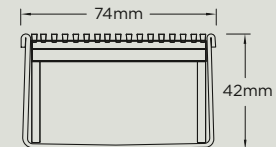

65ARi40MTL

65TR

The 65TR is a standard grate design featuring a 3mm wire/5mm gap.

Manufactured from 316 marine grade the 65TR25 is 65mm wide and available in both 25mm and 40mm depths.

316
GRADE

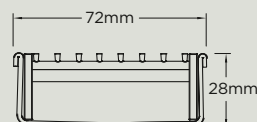

65TRi25
65TRiCO25

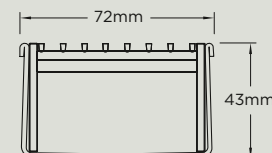

65TRi40

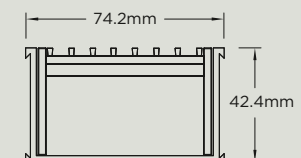

65TRG40

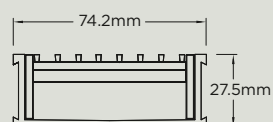

65TRG25

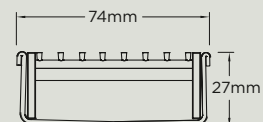

65TRi25MTL

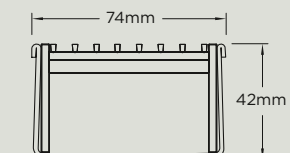

65TRi40MTL

65 Range

65Ti

The 65Ti is a premium tile insert drain that has been designed to blend in with a finished floor.

65Ti30MTL / 65TiCO30 Suits tiles up to 12mm thick.

65Ti40MTL / 65TiG40 Suits tiles up to 16mm thick.

65Ti40 / 65TiG40 Suits tiles up to 20mm thick.

316
GRADE

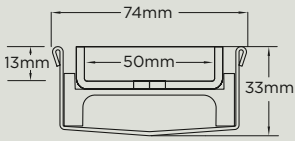

65Ti30MTL
65TiCO30

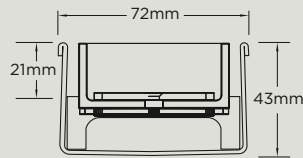

65Ti40

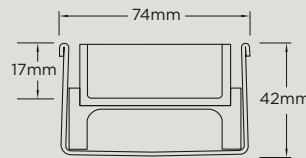

65Ti40MTL

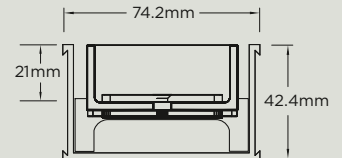

65TiG40

65TRTi

The 65TRTi is a standard Tile Insert drain designed to blend in with a tiled floor.

The standard tile insert is made from 1.5mm thick sheet.

The 65TRTi series is suitable for up to a 8mm thick tile.

316
GRADE

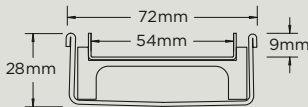
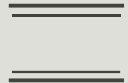

65TRTi25
65TRTiCO25

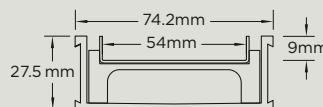

65TRTiG25

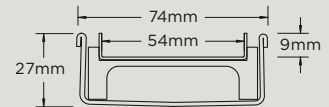

65TRTi25MTL

65MND25

Our designer grate featuring a tessellated hexagonal design created by Marc Newson.

Manufactured from 316 marine grade stainless steel. 65mm wide and 25mm deep as Made-to-Length, Modular Kits & Fixed-Length Units.

AVAILABLE FINISHES Stainless Steel / Black / White / Brass / Blue

5
FINISHES

316
GRADE

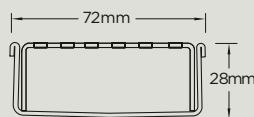

65MNDi25
65MNDiCO25

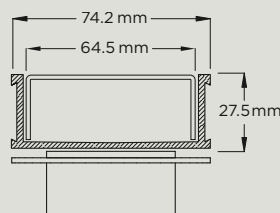

65MNDG25

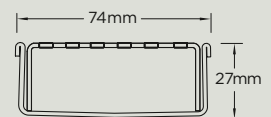

65MNDi25MTL

65PS

The 65PS is a Punched Slot grate design.

Manufactured from 316 marine grade the 65PS is 65mm wide and available in both 25mm and 40mm depths.

316
GRADE

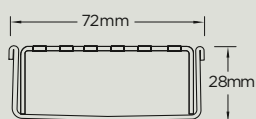

65PSi25
65PSiCO25

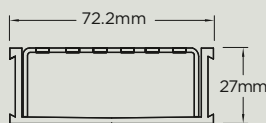

65PSG25

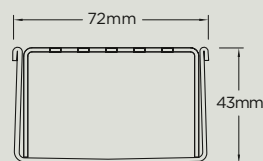

65PSi40

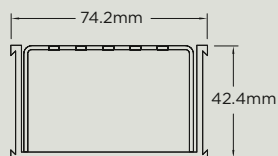

65PSG40

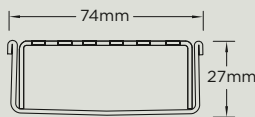

65PSi25MTL

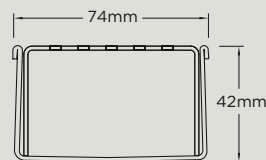

65PSi40MTL

65PH

The 65PH is a Punched Hole grate design.

Manufactured from 316 marine grade the 65PH is 65mm wide and available in both 25mm and 40mm depths.

316
GRADE

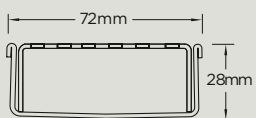
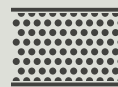

65PHi25
65PHiCO25

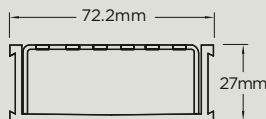

65PHG25

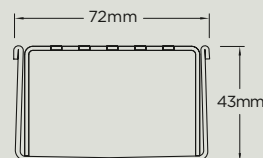

65PHi40

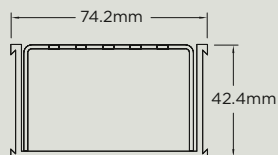

65PHG40

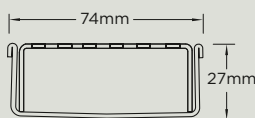

65PHi25MTL

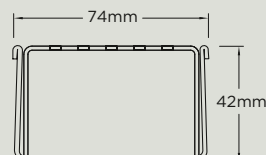

65PHi40MTL

38 Range

Available
Grate Styles



AR



PS

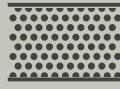

PH

38AR

The **38AR** is a premium architectural grate design featuring a 2mm wire/2.5mm gap.

Manufactured from 316 marine grade the 38AR is 38mm wide and 40mm deep.

316
GRADE

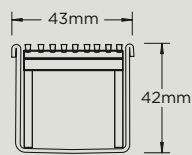

38ARi40MTL

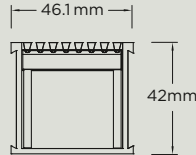

38ARG40

38PS

The **38PS** is a Punched Slot grate design.

Manufactured from 316 marine grade the 38PS is 38mm wide and 40mm deep.

316
GRADE

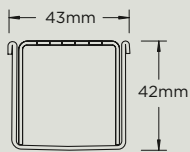

38PSi40MTL

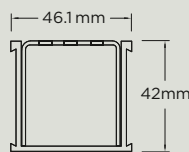

38PSG40

38PH

The **38PH** is a Punched Hole grate design.

Manufactured from 316 marine grade the 38PH is 65mm wide and 40mm deep.

316
GRADE

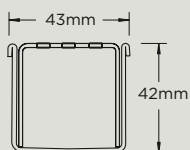
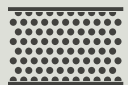

38PHi40MTL

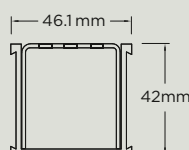

38PHG40

Square Range

Available
Grate Styles



AR



TR



Ti

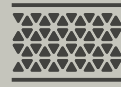

MND



PS

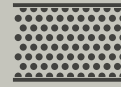

PH

SQ

Square drain units are manufactured from 316 marine grade stainless steel.

316
GRADE

The SQ Range of floor waste units allow the integration of a standard floor waste with Stormtech linear drainage.

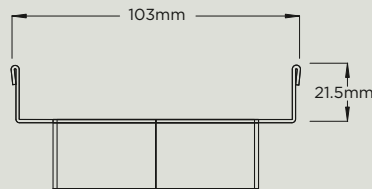

SQ100AR SQ100TR SQ100MND
SQ100PS SQ100PH

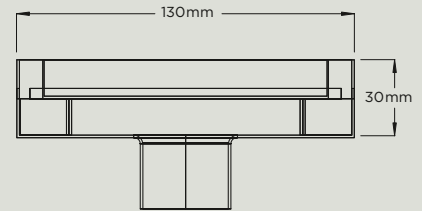

SQ100Ti

Available
Grate Styles



AR

Vinyl Clamp

VC

Designed specifically for vinyl floor environments, the VC range of drain units are manufactured from 316 marine grade stainless steel.

316
GRADE

Stainless steel vinyl clamp drainage unit for use in a vinyl floor environment.

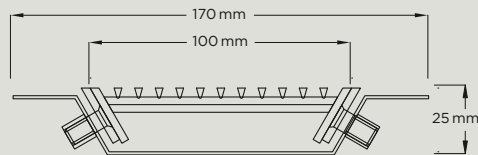

VC100-25

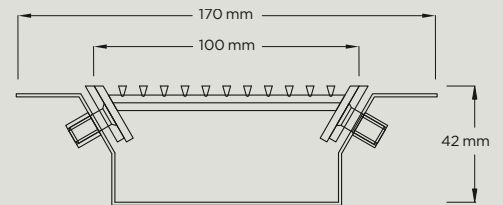

VC100-42

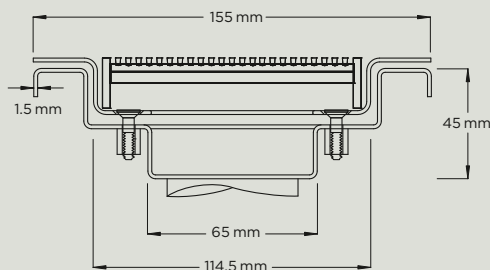

VC100-45

Threshold Range

Available
Grate Styles



AR

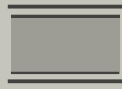

Ti



PS

TD

Featuring a linear stainless steel grate or tile insert with concealed channel section connecting sill and sub-sill for door tracks and thresholds.

316
GRADE

Allows door sills to be drained while having internal and external floor surfaces with no step down.

Sill + Sub-Sill Usage

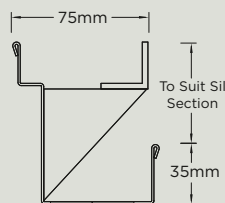

65ARTDi
65TiTDi
65PSTDi

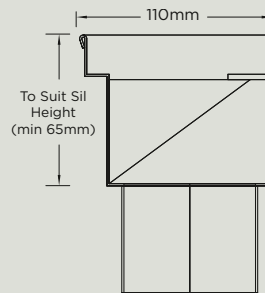

100ARTDi
100TiTDi
100PSTDi

Sill Only Usage

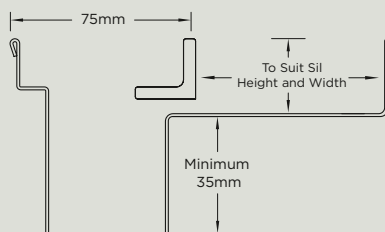

65ARTDiS
65TiTDiS
65PSTDiS

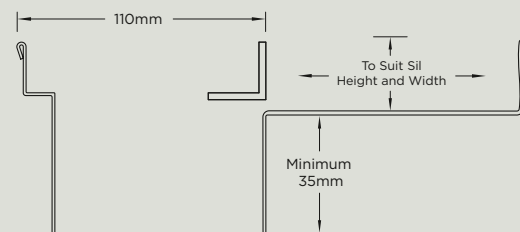

100ARTDiS
100TiTDiS
100PSTDiS

Special Assembly

Special Assembly

Developed for high capacity drainage needs, providing flexibility in landscape and pool design.

The Special Assembly Range features a drainage channel connected via downpipes at 200mm intervals to a drain pipe below.

The system is completed with a AR40, TR40, PS40, PH40 (65G100) or 38AR40, 38PS40 or 38PH40 grate

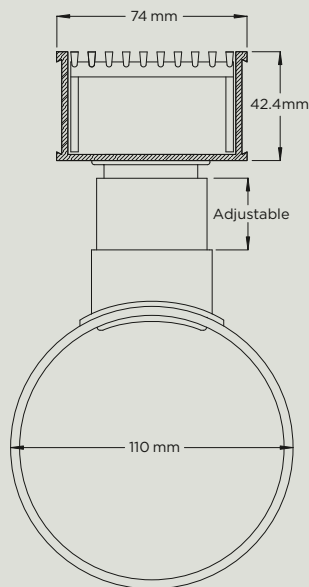

65G100

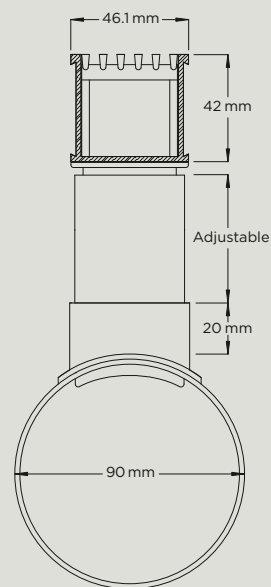

38G90

Available
Grate Styles



AR

Slot Drain

SD

The SD90 features a 25mm opening on the top with 20 slots draining into a concealed 90mm drain pipe.

The Slot Drain can be completed with a 30mm wide architectural wedge-wire grate as an optional item.

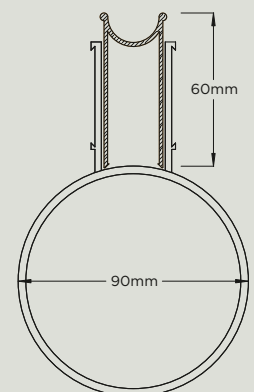

SD90

Standard Installation

These drawings illustrate our standard installation. Product specific diagrams and CAD drawings are available from our website.

Standard Installation

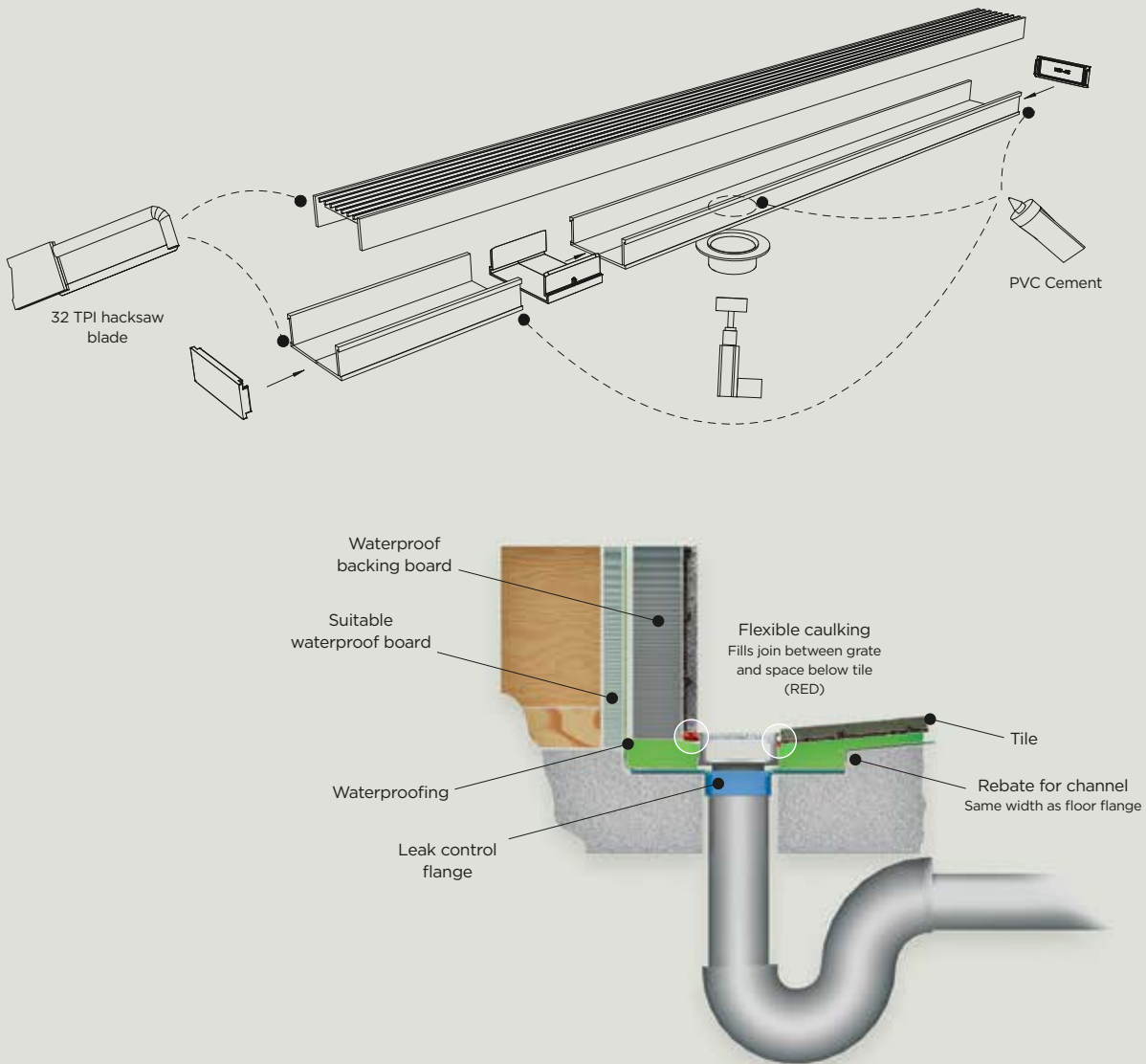

Contact us to assist with product selection for AS3500 installation requirements.

Product Selector

Match your preferred Grate + Range + Drain Depth + Kit Type.

Drain Depth

COLOUR GUIDE

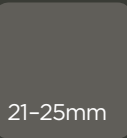

21-25mm



26-35mm



40-45mm



AR
Architectural

RANGE - WIDTH -	MODULAR KITS		MADE TO LENGTH - CUSTOM OUTLET -	FIXED-LENGTH - CENTRE OUTLET -
	uPVC Channel	Stainless Steel Channel	All Stainless Steel	All Stainless Steel
38mm	38ARG40		38ARi40MTL	
65mm	65ARG25	65ARi25	65ARi25MTL	65ARiCO25
	65ARG40	65ARi40	65ARi40MTL	
100mm	100ARG20	100ARi20	100ARi20MTL	100ARiCO20
	100ARG30		100ARi40MTL	



TR
Standard Range

65mm	65TRG25	65TRi25	65TRi25MTL	65TRiCO25
	65TRG40	65TRi40	65TRi40MTL	
100mm	100TRG20	100TRi20	100TRi20MTL	100TRiCO20
			100TRi40MTL	

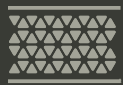

MND
Marc Newson Design

65mm	65MNDG25	65MNDi25	65MNDi25MTL	65MNDiCO25
	65MNDGP25	65MNDiP25	65MNDiP25MTL	65MNDiCOP25
100mm	100MNDG20	100MNDi20	100MNDi20MTL	100MNDiCO20
			100MNDiP20MTL	100MNDiCOP20



PS
Punched Slot

38mm	38PSG40		38PSi40MTL	
65mm	65PSG25	65PSi25	65PSi25MTL	65PSiCO25
	65PSG40	65PSi40	65PSi40MTL	
100mm	100PSG20	100PSi20		100PSiCO20

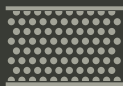

PH
Punched Hole

38mm	38PHG40		38PHi40MTL	
65mm	65PHG25	65PHi25	65PHi25MTL	65PHiCO25
	65PHG40	65PHi40	65PHi40MTL	

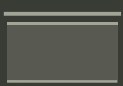

Ti
Tile Insert

65mm	65TiG40	65TiI40	65TiI30MTL	65TiIcO30
			65TiI40MTL	
100mm			100TiI30MTL	100TiIcO30
			100TiI40MTL	

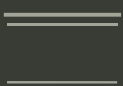

TRTi
Standard Range
Tile Insert

65mm	65TRTiG25	65TRTiI25	65TRTiI25MTL	65TRTiIcO25
100mm			100TRTiI25MTL	100TRTiIcO25

stormtech.com.au

PRODUCT DETAILS

For full product details, including assembly and installation information, visit our website.

TECHNICAL DRAWINGS

To assist planning your project we provide complete CAD files for download from our website.

DISTRIBUTORS

To find a distributor near you, please visit our website or call our office.

Telephone 1300 653 403

Email info@stormtech.com.au